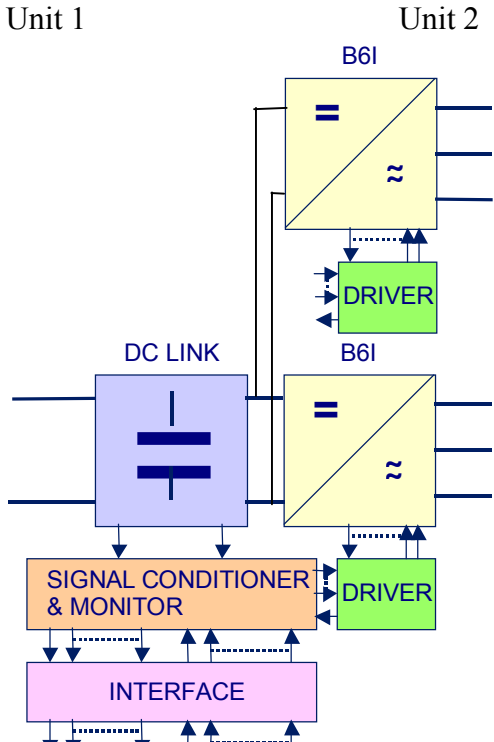

Key Data

3 x 800A AC at 690V AC, watercooled

General Information

Stack with IGBT, heatsinks, capacitors, drivers and sensors for several inverter applications. These are only technical data! Please read heedful the complete documentation and attend the adopted design environment! Especially the EMC environment and the controller functionality.

Topology	DC Link + 2B6I		Unit 1	Unit 2
Load Type	Resistive, inductive load			
Cooling	By Water			
Targed Application	Industrial Drive			
Extra	Available in Master [M] or Slave [S] Configuration			
Drivercore	Scale Driver			
Monitors	Current-, Voltage-, Temperature-Monitoring			
Module (Unit1)		n.a.		
Module (Unit2)	IGBT	6x FF800R17KF6C		
Interface	Electrical, opt. optical			
Standards	EN50178, UL94, prepared for UL508C			
Product ID (eupec)	Master	23482		
	Slave	23483		
Drawing No.	38000002_B_MB			
Circuit Diagram No.	57000002			

Electrical Data

	Parameter		Min	Typ	Max	
Assumed Linevoltage	For Isolation-Management	VLine		690		VRMS
DC Link Voltage		VDC		975	1219	Vav
DC Link Overvoltage Shutdown	Within 100µs			VDCmax		V
DC Link Current	At IUnit2, VUnit2, cos φUnit2	IDCLink Input		890		Aav
Voltage Unit1		VUnit1		-		VRMS
Continuous Current Unit1	ϑ=ϑair_inlet	IUnit1			-	ARMS
Shorttime Current Unit1	10s, every 180s, initial load = IUnit1	IUnit1_10			-	ARMS
Pulse Current Unit1	Sinehalfwave 20ms				-	Apeak

DC Current at Unit1	No rotating field, $\vartheta = \vartheta_{air_inlet}$,	IUnit1_DC			-	Aav
Overcurrent Shutdown Unit1	Percentage of IUnit1. Within 15 μ s				-	%
Switching Freq. Unit1		fsw1			-	Hz
Power Losses Unit1	$V = V_{unit1_min}$, $I = I_{Unit1}$, $fsw = fsw1$	Ploss1			-	W
Voltage Unit2	Depending on Controller	VUnit2		690		VRMS
Displacement factor		cos_φUnit2	-0,9		+0,9	
Continious Current Unit2	$\vartheta = \vartheta_{water_inlet}$, $\vartheta_{chip} \leq 125^{\circ}C$ $f_{Unit2} > 5Hz$ Both B6I connected in parallel (1U1 ->2U1..)	IUnit2			800	ARMS
Shorttime Current Unit2	$\vartheta_{water_inlet} \leq 40^{\circ}C$, 10s, every 180s, initial load = IUnit2	IUnit2_10			960	ARMS
Pulse Current Unit2	Sinehalfwave 20ms, starting from IUnit2.	IUnit2peak			-	Apeak
DC Current at Unit2	No rotating field, $\vartheta = \vartheta_{air_inlet}$,	IUnit2_DC			0,4* IUnit2	ADC
Overcurrent Shutdown Unit2	Percentage of IUnit2. Within 15 μ s			125		%
Switching Freq. Unit2		fsw2			2250	Hz
Power Losses Unit2	$I = I_{Unit2}$, $fsw = fsw2$	Ploss2		10000		W
Power Losses (PCB and Capacitor)		Ploss_aux			400	W
Filterresistors at Output Unit2	Applicable for Sinewavefilters (damping, optionally)	RFilter		-		Ohm
		PRFilter		-		Watt
Auxiliary Voltage		Vaux	18	24	30	Vav
Auxiliary Power Demand	$V_{aux} = 24 V_{av}$, to feed with B6U	Paux	80			W
EMC Test	According EN61800-3 at named interfaces	Power	VBurst	2		kV
		Control	VBurst	1		
		Aux (24V)	VSurge	1		kV
Insulation Test Voltage	According EN50178 $f = 50Hz$, $t = 1min$	Visol		1,8		kVRMS

Important Component Data

DC Link Capacitor		CDC		15,66		mF
DC Link Capacitor		Type	Elcap			
Capacitor Design Lifetime	Loadcycle for: Wind	LTD		-		Year
	Loadcycle for: Solar	LTD		-		Year

(eupec approximation)	Loadcycle for: Industrial Drive ($\vartheta_{air}=35^{\circ}\text{C}$, $I=0,8$, Duration=24h/Day)	LTD		11		Year
-----------------------	---	-----	--	----	--	------

Requirements to the Powersource

Assumed Inductance Of Feeding Powersource	(Necessary inductance not included, feeded by B6U)	LFeed		110		μH
---	--	-------	--	-----	--	---------------

Fan Data (assumed when excluded)

Fan Type	Assumed			-		
Fan Voltage		VFan		-		VRMS
Fan Frequency		fFan		-		Hz
Fan Current		IFan		-		ARMS
Fan Air Pressure	Assumed	Δp_{AirFan}		-		Pa

Controller Interface Data

Driver	See Datasheets	PCB	TR100			
Paralleling Interface	Master (only first B6I)	PCB	SAD101			
	Slave See Datasheet		-			
Optical Interface	Master (only first B6I) (optionally)	PCB	OEA101			
	Slave See Datasheet		-			
Digital Input Level	Resistor to Gnd (1,8k) High = on min 15mA	Vin	0		15	V
Digital Output Level	Open collector Low = ok max 15mA	Vout	0		15	V
Analog Current Outputs Unit1	Load max 1mA at IUnit1			-		V
Analog Current Outputs Unit2	Load max 1mA at IUnit2			4		V
Analog DC Link Voltage Output	Load max 1 mA At VDCmax	VDCout		9		V
Analog Temperature Out	Load max 1mA At $\vartheta_j=125^{\circ}\text{C}$	V ϑ out		9		V
Optical Input Level	optionally		12			μW
Optical Output Level	optionally				60	μW

Requirements to the Controller

EMC Protection	According EN61800-3 at auxiliary power and controlinterface		1			kV
----------------	---	--	---	--	--	----

EMC Environment			Shieldconcept with TE (True Earth) separated from PE, HF conform installation			
Drive Pulse Time		ton_min	10			μs
Blockout Time		tpause	10			μs
Overvoltage Shut Down Reaction Time	After overvoltage message by PowerSTACK Interface				50	μs
Overcurrent Shut Down Reaction Time	After overcurrent message by PowerSTACK Interface				10	μs

Mechanical Data

Airvelocity	ϑ _{Air} =20°C P _{Air} =1013 hPa Dry- and dustfree, measured outside of heatsink. According DIN 41882	v _{Air}	-			m/s
Airflow heatsink		dV/dt _{Air}	-			m ³ /h
Air Pressure Drop heatsink		Δp _{Air}		-		Pa
Waterflow heatsink	According Coolingwater Specification from eupec for copper tubes	dV/dt _{Water}	16			l/min
Water Pressure Drop heatsink Max. Water Pressure		Δp _{Water}		200 8		mbar bar
Water connection (Tube diameter)				3/4"		Inch
Dimensions	Width x Depth x Hight		1090	596	250	mm
Mass	Approximation			101		kg
Storage Temperature Range		ϑ _{stor}	-40		+65	°C
Operating Temperature range (PCB and Capacitor)	Minimal 0 °C for optional optical interface	ϑ _{op}	-25 (0)		+55	°C
Cooling Air Inlet Temperature (Heatsink)		ϑ _{air_inlet}	-		-	°C
	Heatsink temperature > -25°C		-			
Cooling Water Inlet Temperature (Heatsink)		ϑ _{water_inlet}	-25		+40	°C
Cooling Airvelocity (PCB and Capacitor)		v _{Air_PCB}	2			m/s
Air Pressure	Standard atmosphere	p _{Air}	900		1100	hPa
Humidity	No Condensation	Rel. F	0		95	%
Installation Height			0		1000	m
Vibration	EN60068-2-6, Fc				10	m/s ²

PowerSTACK



Datasheet: 2B6I 690/1100-400W M, S

Preliminary Data

	10..59Hz 0,075mm					
Permanence Vibration	EN60068-2-6, Fc 10-150Hz, 20 Cycles				20	m/s ²
Shock	EN60068-2-27, Ea Halfsine 11ms, 3 pulses				100	m/s ²
Protection Degree				IP00		
Pollution Degree				2		
Overvoltage Category				III		

Derating Curves (IGBT Part)

Current derating at low rotating field frequency (f_0). **Maximal 100% current is allowed.**

$\cos(\phi) = 0.64$, (motor)
 $\Theta_{air} = 40^\circ\text{C}$

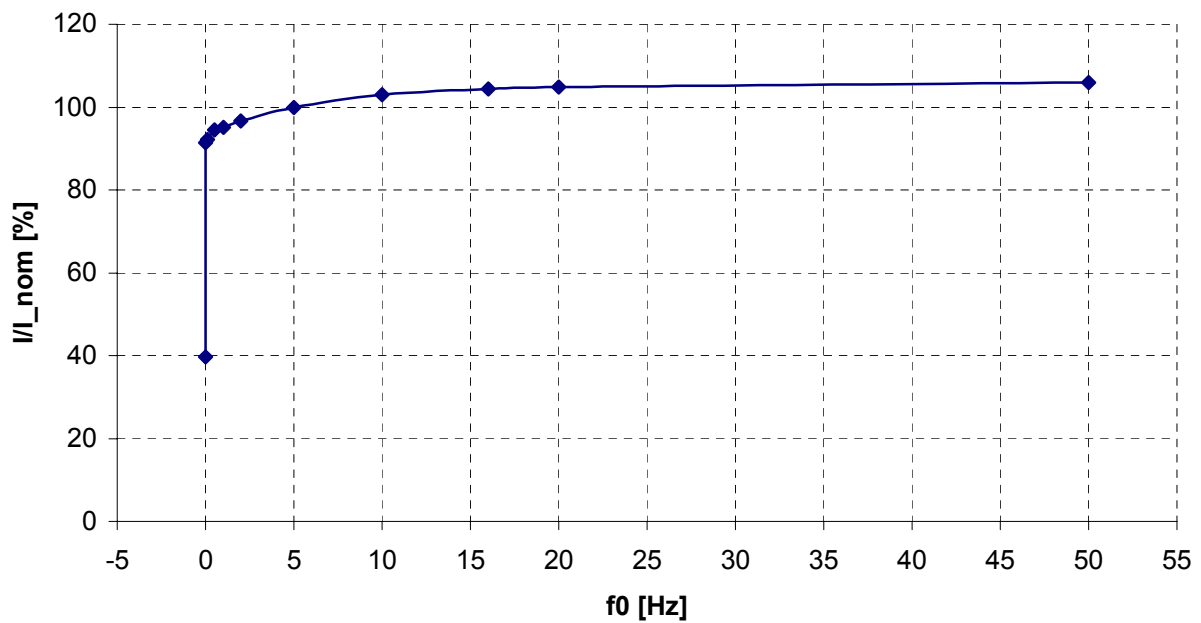

$\cos(\phi) = -0.64$, (generator)
 $\Theta_{air} = 40^\circ\text{C}$

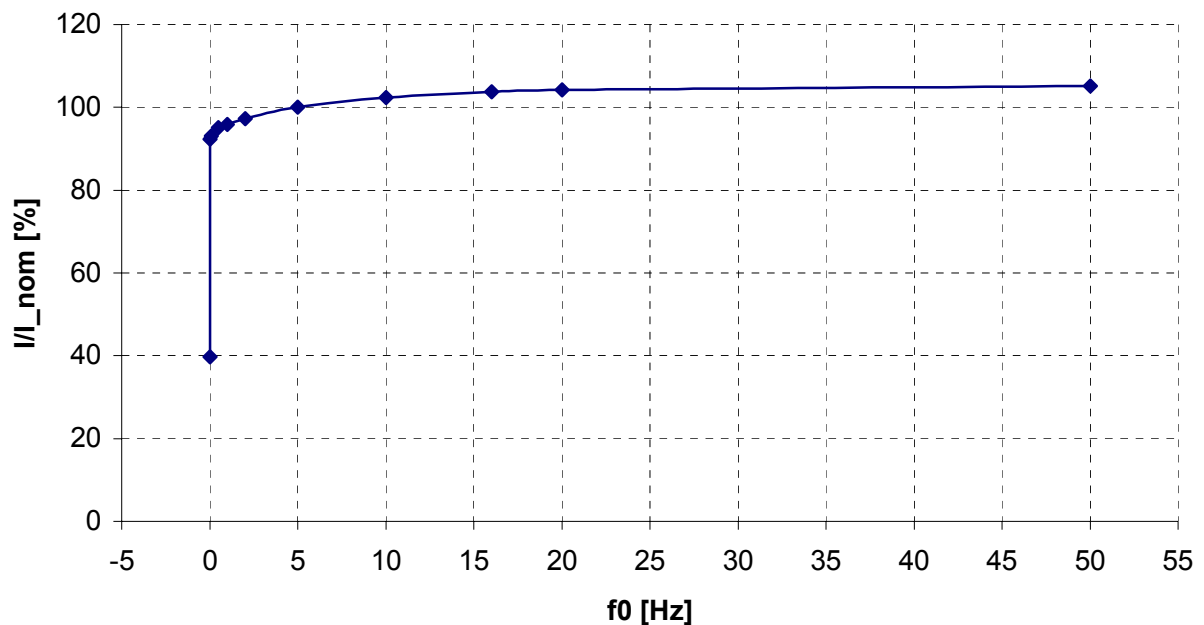

Current derating at different switching frequencies. See datatable for nominal switching frequency. In this drawing 2500Hz ist assumed. **Maximal 100% current is allowed.**

**IGBT, $\cos(\phi) = 0.64$
 $\Theta_{air} = 40^\circ\text{C}$**

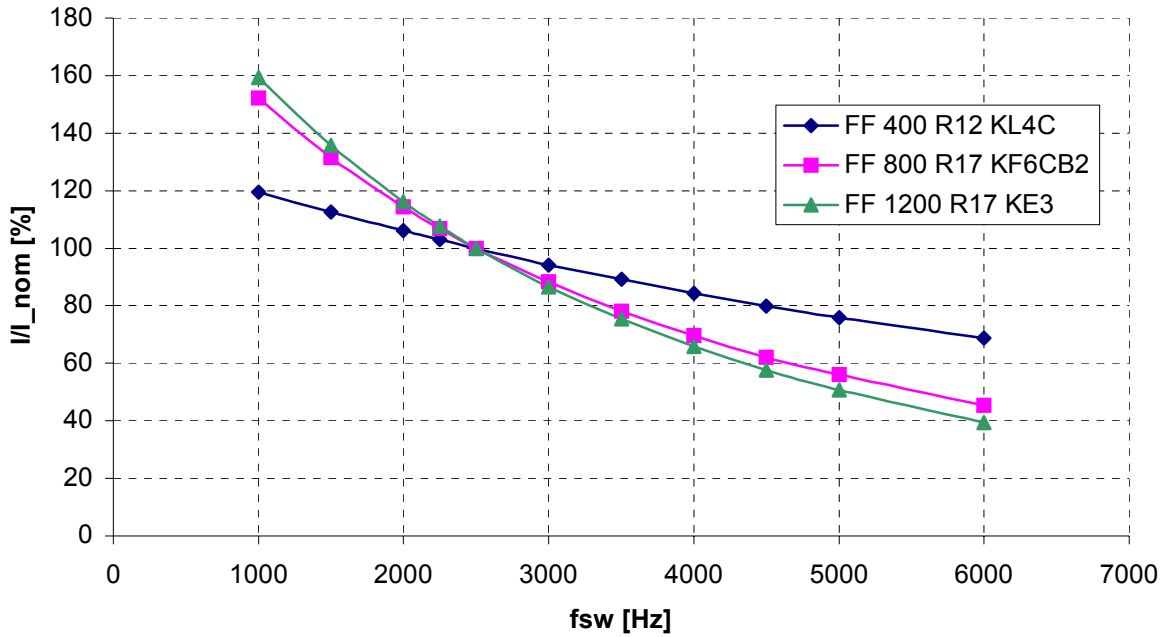

**Diode, $\cos(\phi) = 0.64$
 $\Theta_{air} = 40^\circ\text{C}$**

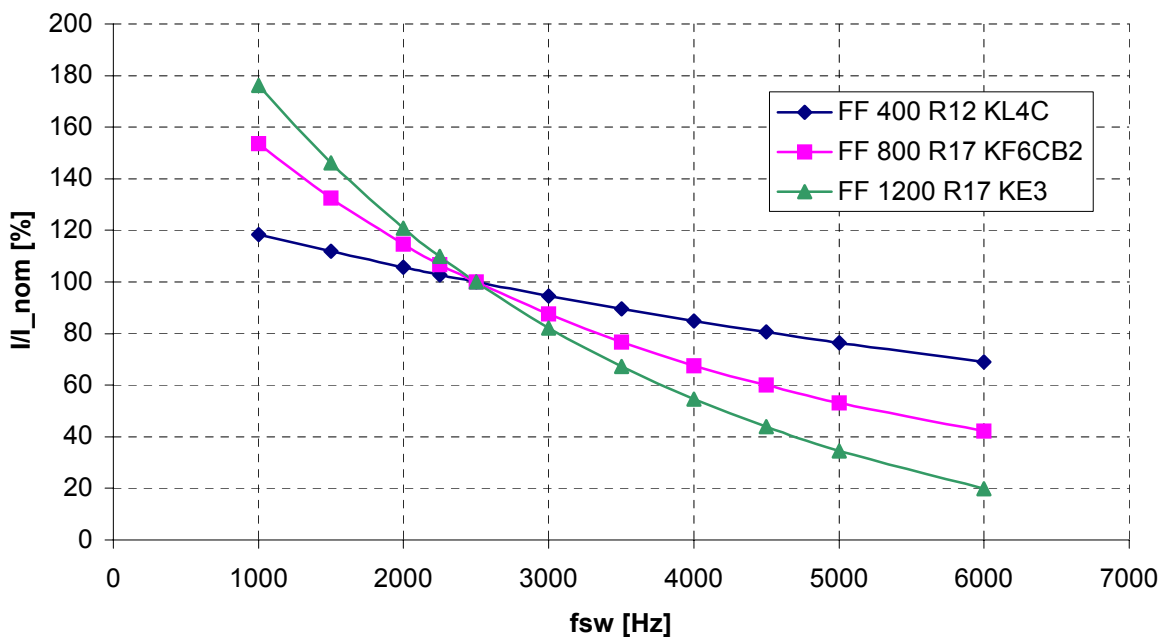

IGBT, $\cos(\phi) = -0.64$
 $\Theta_{air} = 40^{\circ}\text{C}$

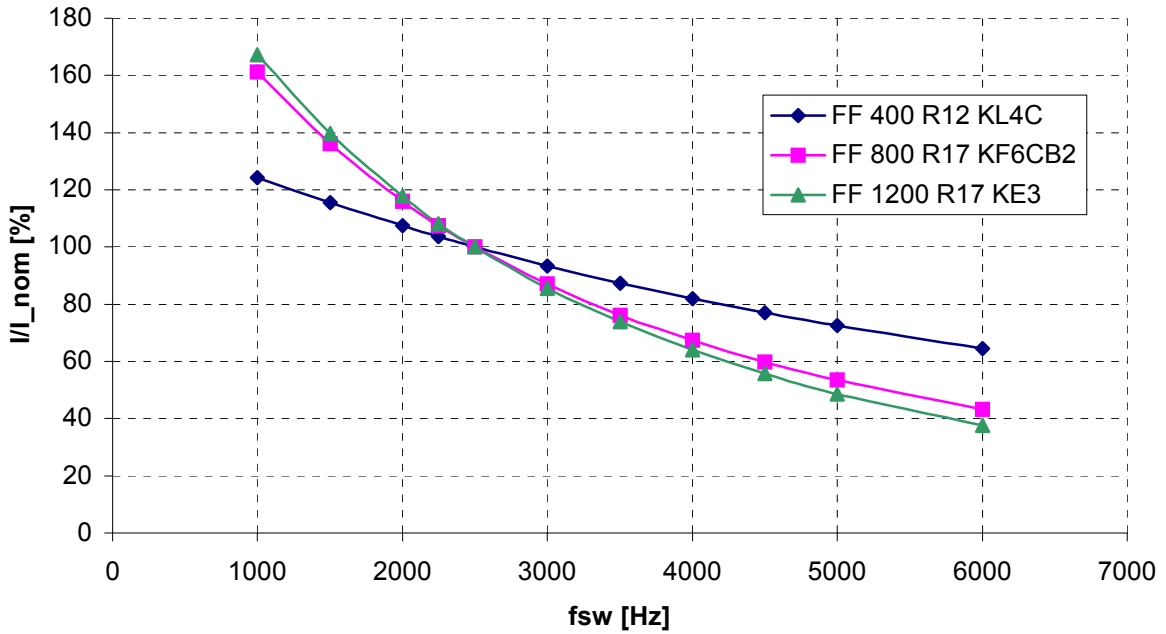

Diode, $\cos(\phi) = -0.64$
 $\Theta_{air} = 40^{\circ}\text{C}$

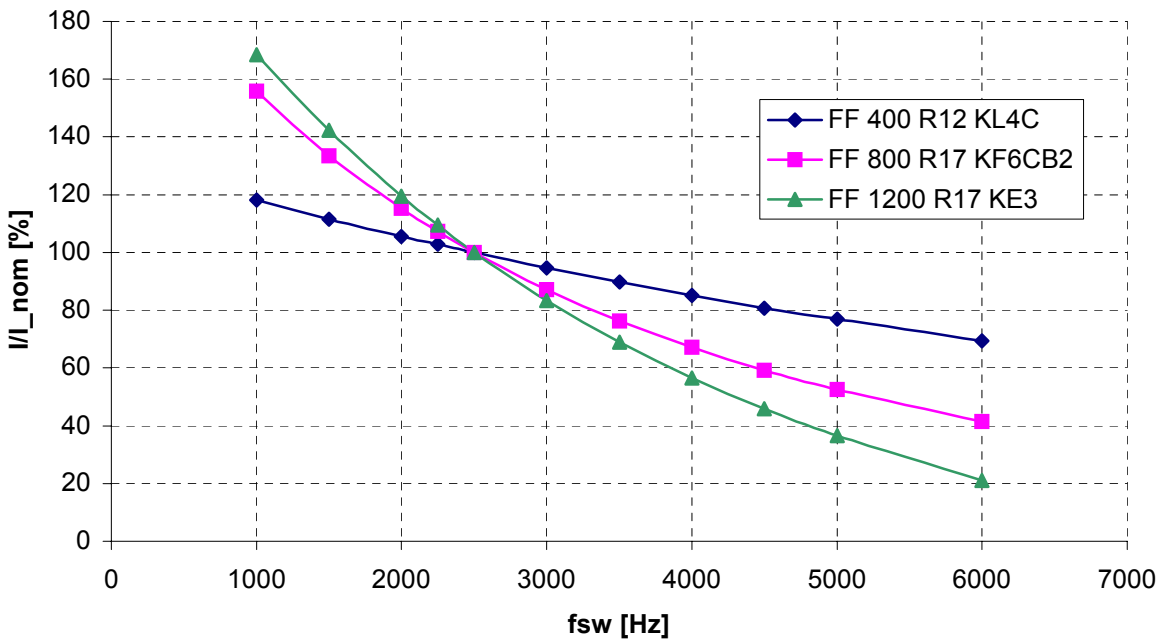

Miscellaneous

This technical information specifies semiconductor stacks but promises no characteristics. It is valid in combination with the belonging technical notes.

This document may be changed without prior notice.

Warning!

Prior to installation and commissioning all safety notices and warnings and all warning signs attached to the equipment have to be carefully read. Make sure that all warning signs remain in a legible condition and missing or damaged signs are replaced.

The safety instructions have to be strictly adhered to.

The manual contains detailed information on all technical topics with regard to the eupec PowerSTACK. For further details regarding publications of the eupec PowerSTACK and information on other publications in the area of PowerSTACKs please contact your nearest eupec branch or visit our website: <http://www.eupec.com>.

©eupec GmbH 2003. All rights reserved

Prepared by	J.Schiele	2003-04-03	Date of publication	
Approved by	H.Nübel	2003-04-03	Revision	0

PowerSTACK 2B6I 690/1100-400W M, S, Drawing, Preliminary Data

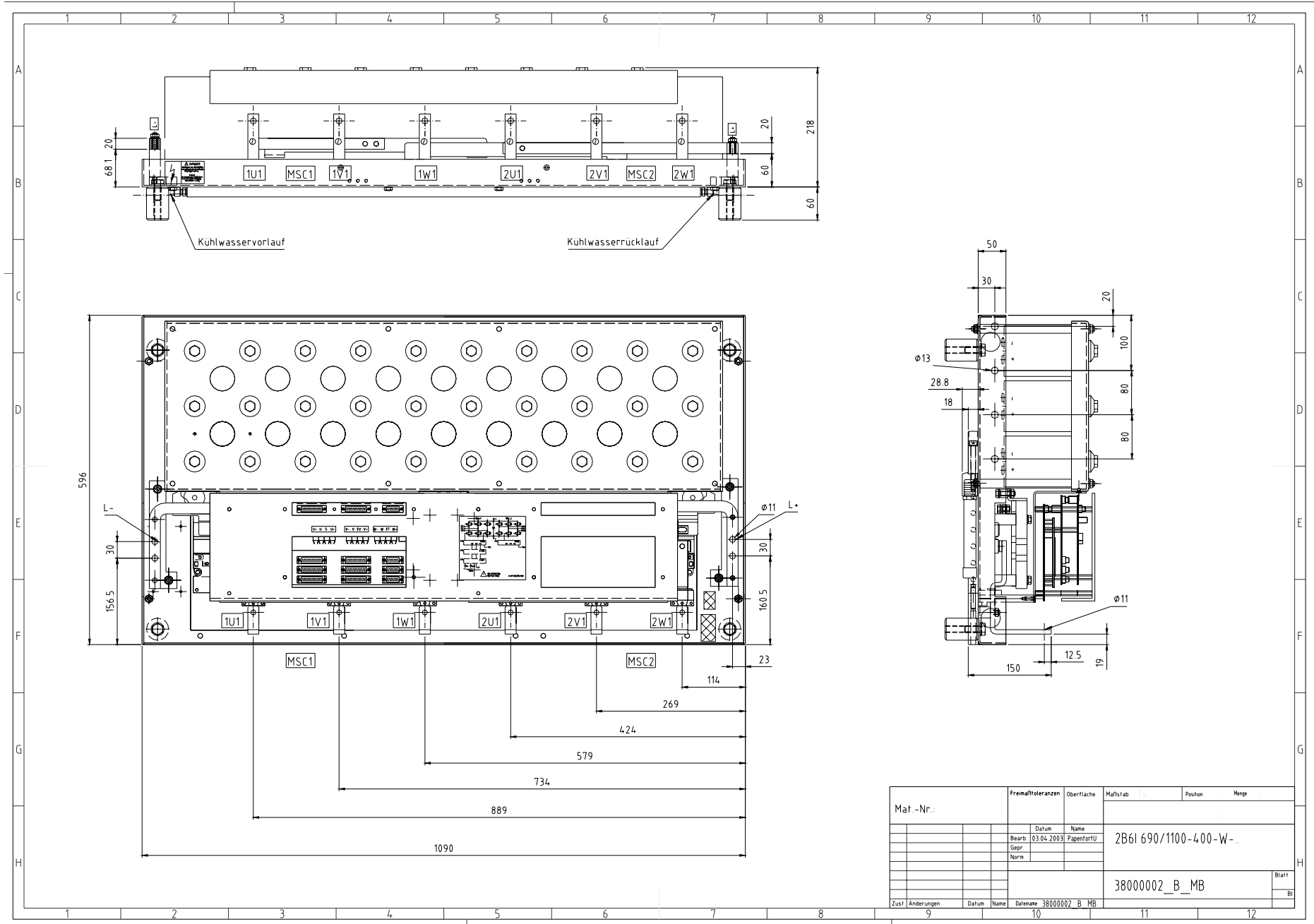

Mat.-Nr.:	Freimaßtoleranzen	Oberfläche	Maßstab	Position	Henge
	Datum	Name			
	Bearb. 03.04.2003	Papenfertig	2B6I 690/1100-400-W...		
	Gepr.				
	Norm				
			38000002_B_MB		Blatt
Zust. Änderungen	Datum	Name	Datenname 38000002_B_MB		Bl